

管道风机
In-line Duct Fan

Φ 125

转子材质 Rotor Material: 铸铝 Aluminum Die-casting

外壳材质 Housing Material: 碳钢 Carbon Steel

防护等级 Ingress Protection: IP44

绝缘等级 Insulation Class: F

轴承类型 Bearing Type: 免维护滚珠球轴承

Maintenance Free Ball Bearing

产品尺寸图 Dimensional Drawings

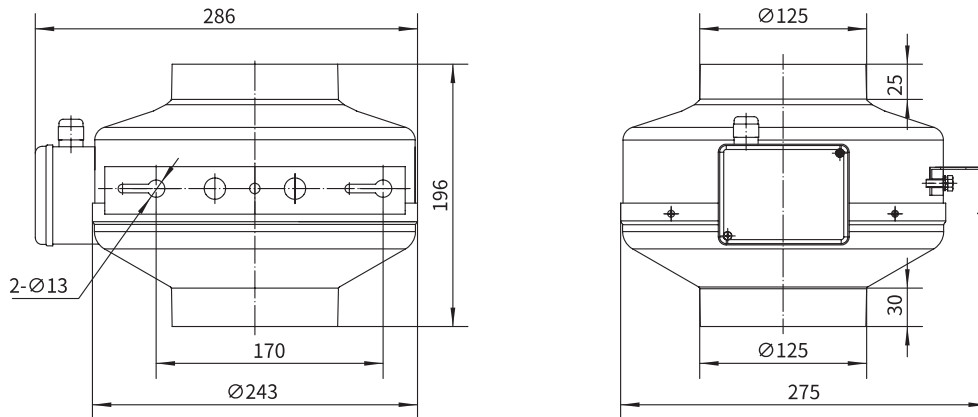

性能曲线 Performance Curves

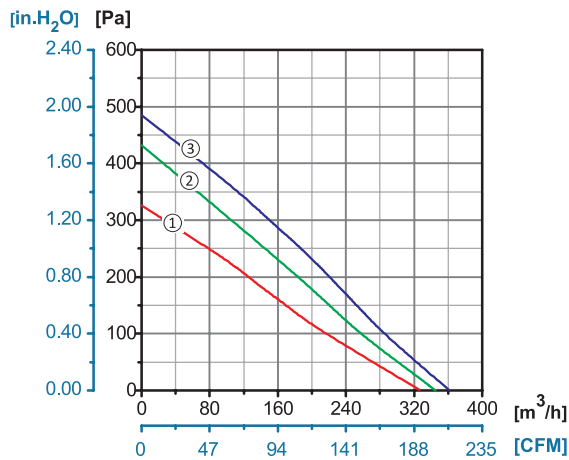

产品型号 Model No.	电压 Voltage	频率 Frequency	电流 Current	功率 Power	转速 Speed	电容 Capacitor	风量 Air Flow (0 Pa)	噪音 Noise	曲线 Curve	运行温度 Working Temp.	认证 Approvals
	V	Hz	A	W	RPM	μF	[m³/h]/[CFM]	dB(A)	No.	Min/Max (°C)	
YWF.G2S-125-196AA2A	110/120	60	0.63	75	2975	8	360/235	63	③	-30/+60	
YWF.G2S-125-196AA20	220/230	50	0.32	70	2620	3	320/180	61	①	-30/+60	CCC, CE
	220/230	60	0.41	86	2940	3	340/200	63	②	-30/+60	CE